

Montage-handleiding elektrokabelset voor  
trekhaak met 12-N contactdoos  
vlg. DIN/ISO norm 1724

Fitting instructions electric wiringkit  
towbar with 12-N socket up to  
DIN/ISO norm 1724

Einbauanleitung Elektrosatz  
Anhängervorrichtung mit 12-N Steckdose  
lt. DIN/ISO Norm 1724

Instructions de montage du faisceau  
électrique pour crochet d'attelage  
conforme à la norme DIN/ISO 1724  
prise 12-N

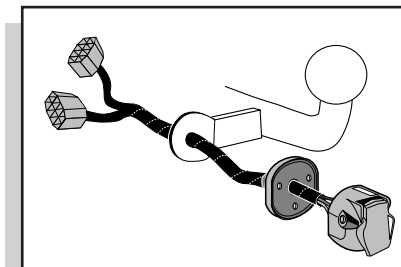

## MAZDA 626 Sedan/Hatchback/Station 1997-

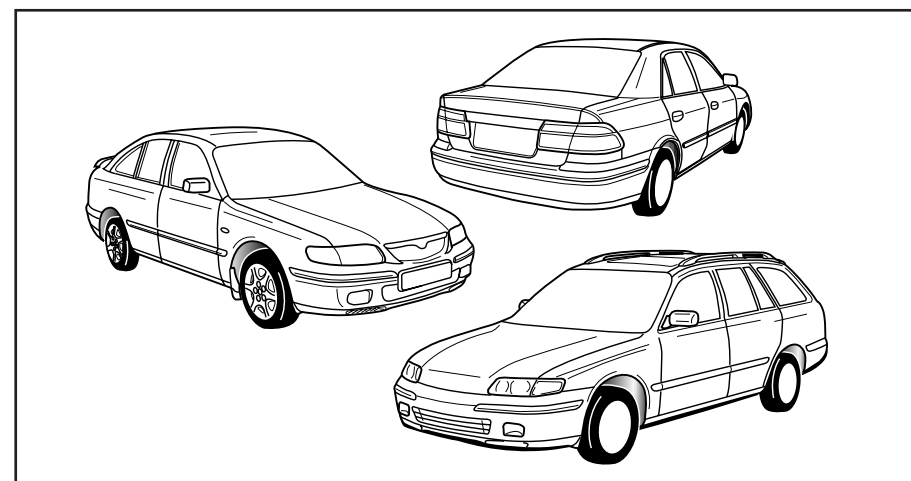

Bestel Nr.: MAZ-049-B



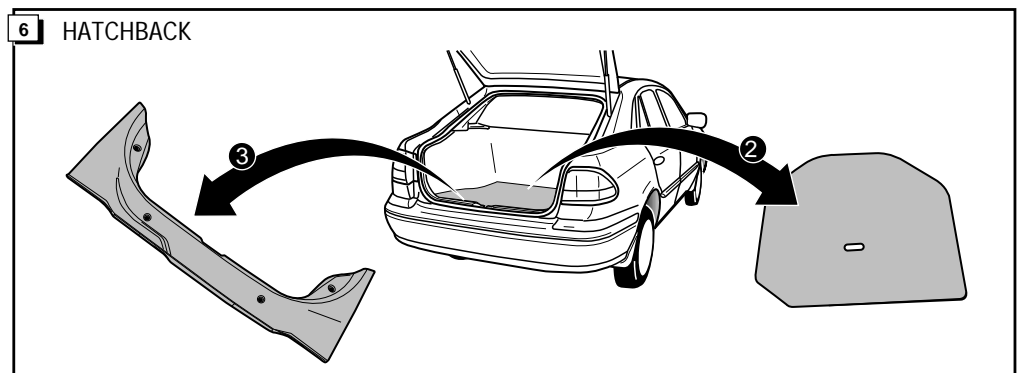
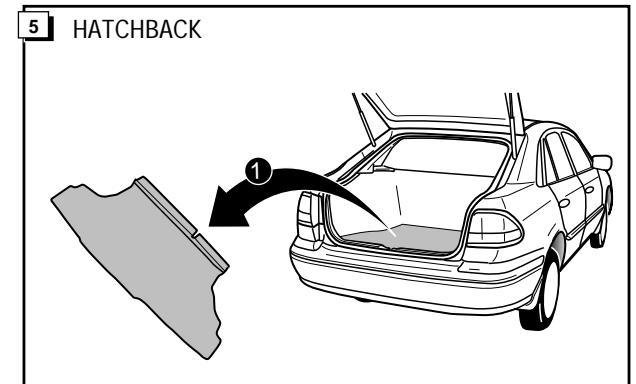
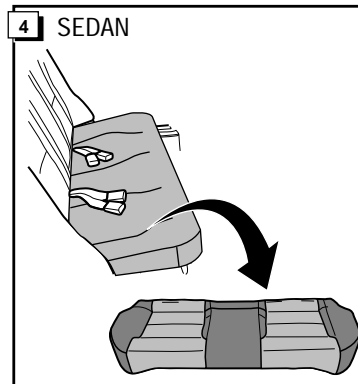
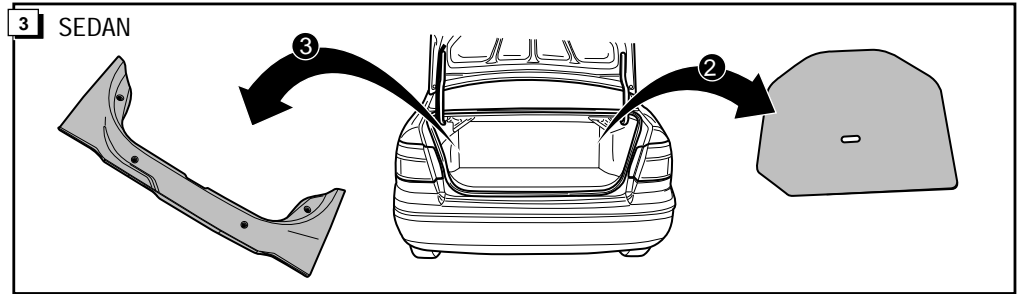
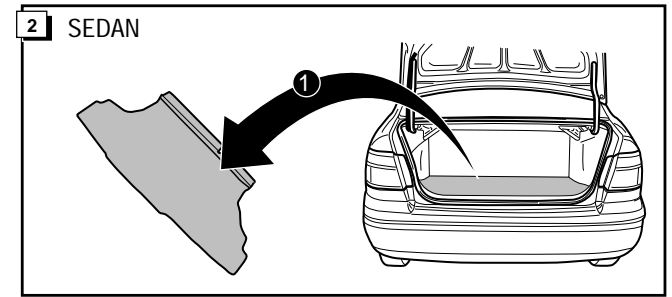
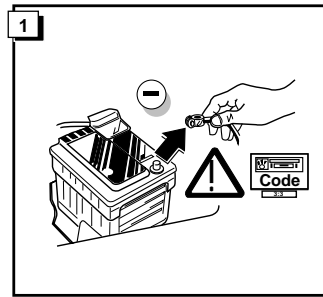

7 STATION

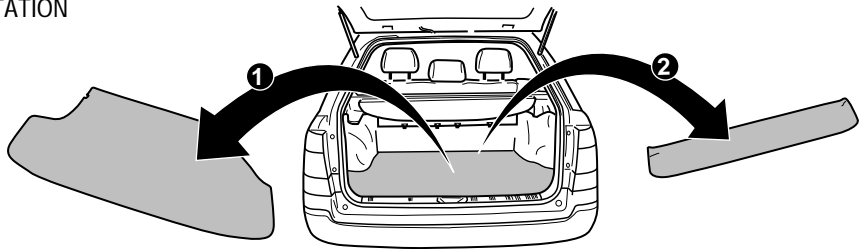

8 STATION

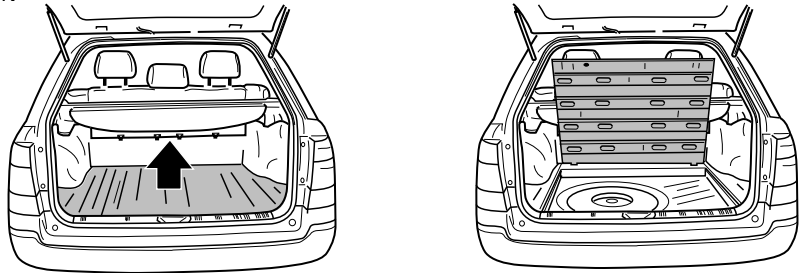

9 SEDAN  
HATCHBACK  
STATION

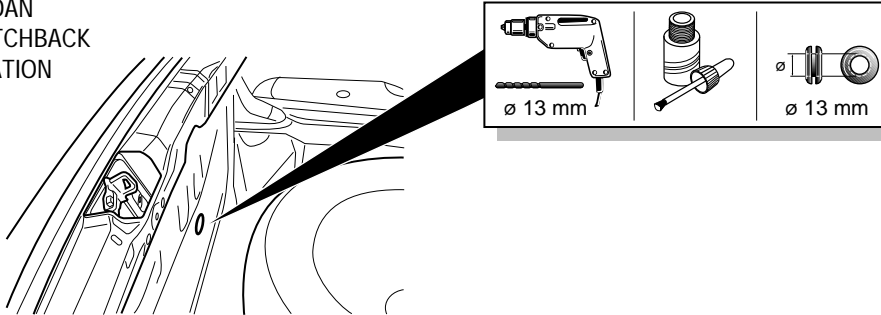

10 SEDAN

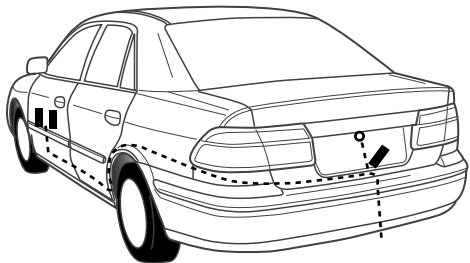

11 HATCHBACK

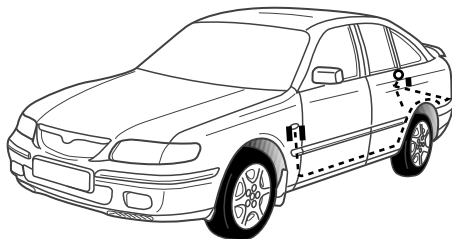

21 STATION

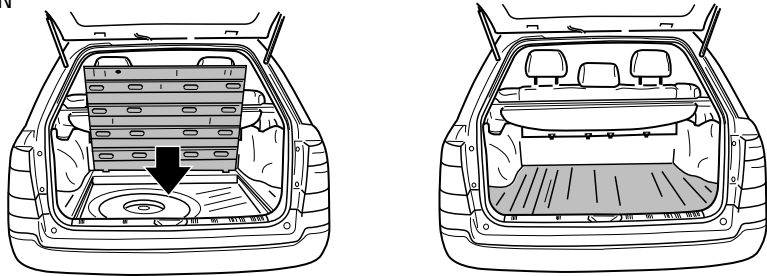

12 STATION

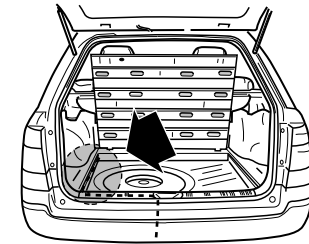
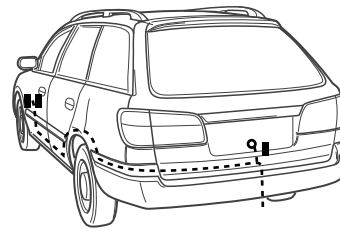

22 STATION

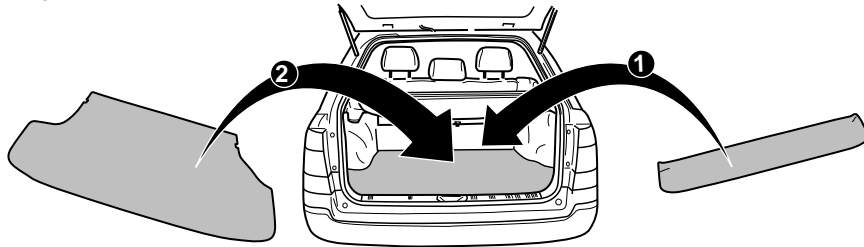

23

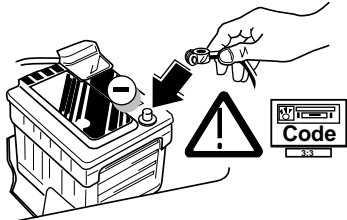

24

**!** **CONTROLEER FUNCTIES !**  
**!** **CHECK FUNCTIONS !**  
**!** **FUNKTIONEN KONTROLIEREN !**  
**!** **CONTRÔLER LES FONCTIONS !**

13

|        | NL    | GB     | D       | F     |
|--------|-------|--------|---------|-------|
| 1=L    | GEEL  | YELLOW | GELB    | JAUNE |
| 2=54-G | BLAUW | BLUE   | BLAU    | BLEU  |
| 3=31   | WIT   | WHITE  | WEIß    | BLANC |
| 4=R    | GROEN | GREEN  | GRÜN    | VERT  |
| 5=58-R | ZWART | BLACK  | SCHWARZ | NOIR  |
| 6=54   | ROOD  | RED    | ROT     | ROUGE |
| 7=58-L | ZWART | BLACK  | SCHWARZ | NOIR  |
| 8=58-B | GRIJS | GREY   | GRAU    | GRIS  |

BLACK JUMPER WIRE

14 SEDAN  
HATCHBACK  
STATION

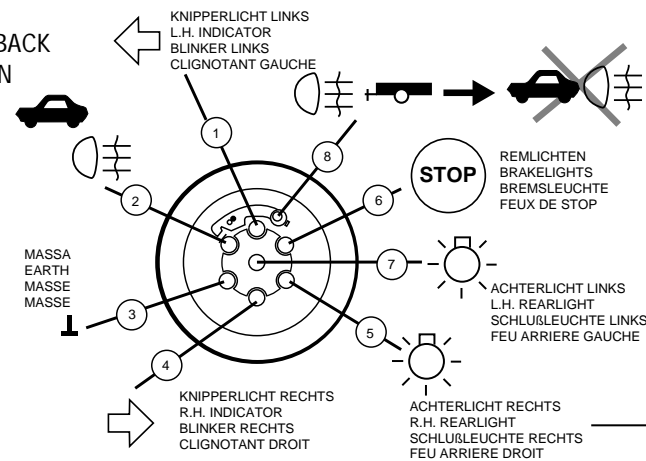

BLACK JUMPER WIRE

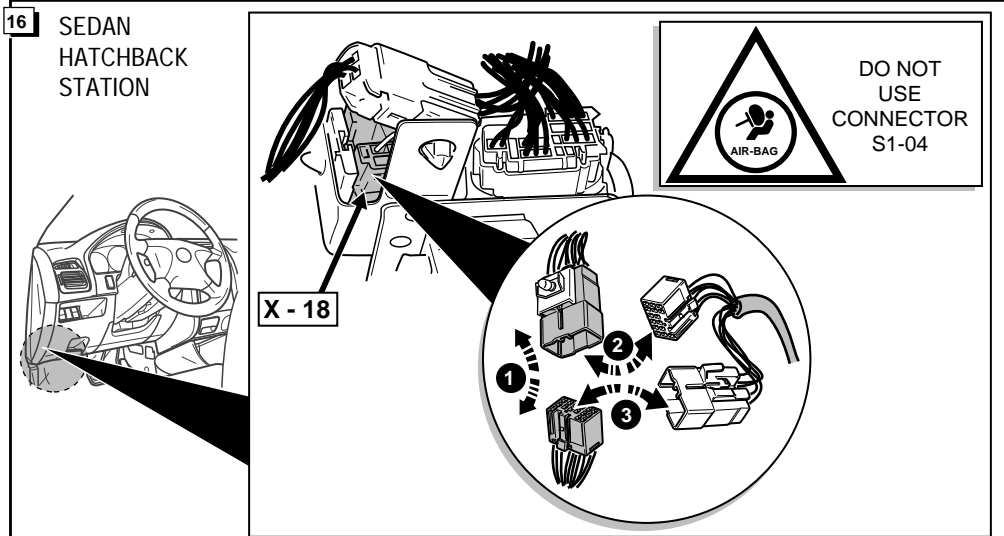
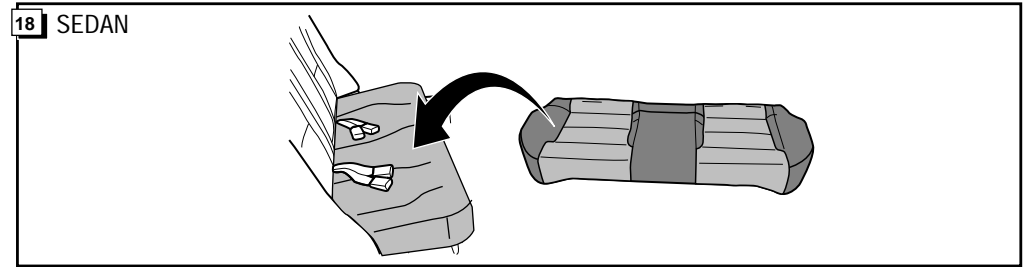
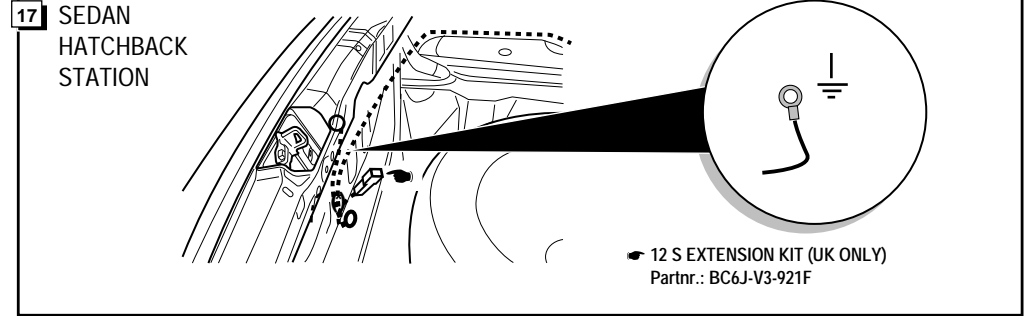
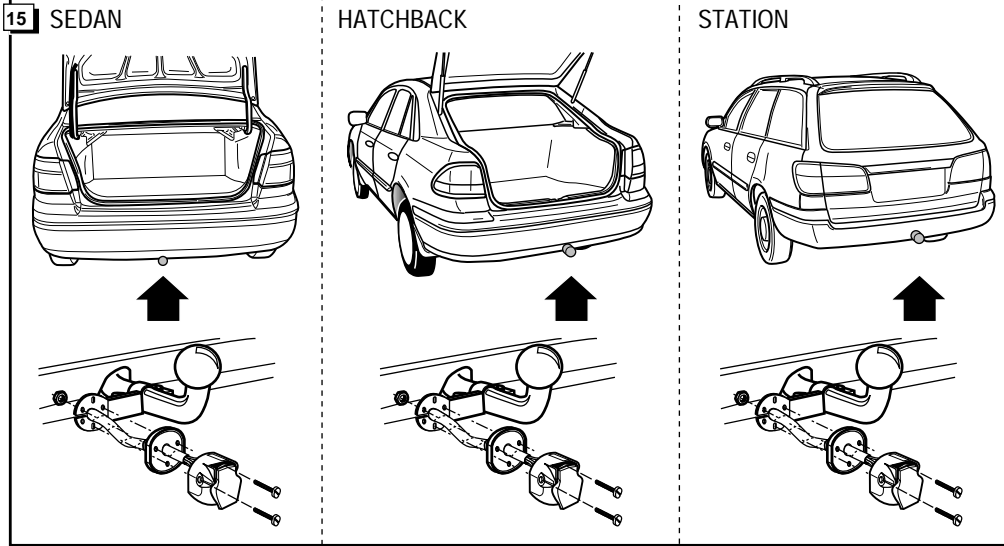

X-18 FRONT(F) - INTERIOR (IN)

| (F)   |        |     |     |      | (IN) |     |     |       |       |
|-------|--------|-----|-----|------|------|-----|-----|-------|-------|
| *     | *      |     |     | R    | *    |     |     | <L/W> | (R/G) |
| (R/G) | <L/W>  |     |     |      | *    |     |     |       |       |
| *     | *      | LY  | G/W | Y/R  | R/B  | *   |     | <R/L> | P     |
| (P)   | <R/L>  |     |     |      |      | Y/R | G/W | LY    |       |
| *     | LG/B   | G/Y | G/B | GY/B | Y/G  | *   |     | G/B   | G/Y   |
|       | (LG/R) |     |     |      |      | *   | *   |       | LG/B  |

[ ] WITH RUNNING LIGHT SYSTEM, <> 5HB, () WITH THEFT-DETERRENT SYSTEM

